

---

*SCO 5.0.5 Driver Installation  
Release Notes*

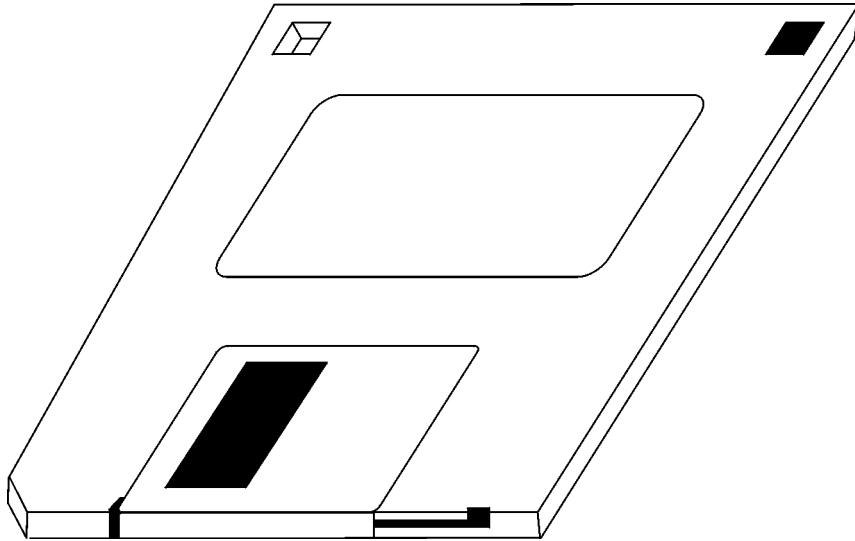

**COMPUTONE**  
Corporation

---

1060 Windward Ridge Parkway  
Suite 100  
Alpharetta, GA 30005-3992  
U.S.A.

No part of this publication may be reproduced, transmitted, transcribed, stored in a retrieval system, or translated into any language, in any form or by any means (electronic or otherwise) without the prior written permission of Computone Corporation.

**Disclaimer:** Computone Corporation ("Computone") makes no representations or warranties with respect to the contents hereof, and specifically disclaims any implied warranties of merchantability or fitness for any particular purpose. Furthermore, Computone reserves the right to revise this publication and make changes from time to time to the contents hereof, without obligation of Computone to notify any person of such revisions or changes.

**Support Information:** If you require technical support, contact your Computone dealer or Computone Technical Support. The Computone Technical Support staff can be reached by phone at the following numbers, from 8:30 a.m. to 8:00 p.m. Eastern time, Monday through Friday:

(800) 241-3946 ext. 2002  
(770) 625-0000 ext. 2002  
(770) 625-0013 (FAX)

Technical Support can be contacted by email at the Internet address [support@computone.com](mailto:support@computone.com)

**Trademarks:** Computone and IntelliServer are trademarks of Computone Corporation. All other brand names or product names are trademarks or registered trademarks of their respective corporations.

Release Notes, SCO 5.0.5 Driver Installation

P/N: 0-28006

---

# SCO 5.0.5 Driver Installation

This publication describes how to install the IntelliPort II software device drivers for SCO UNIX System V, Release 5.0.5. Before you begin, make sure that the operating system is installed and active on your system, and that you have the correct driver software for your operating system.

**NOTE:** The phrases IntelliPort II and IntelliPort Plus are used interchangeably in this document. IntelliPort Plus software is compatible with IntelliPort II cards.

---

## Installation Procedure

Use the following procedure to install the SCO 5.05 drivers:

1. Verify that you are logged in as root. Type *custom* to start the UNIX custom program, as shown in Figure 1.

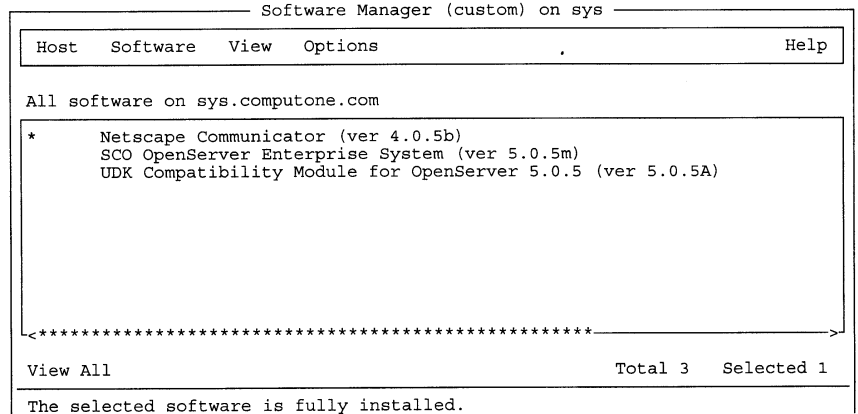

**Figure 1. Software Manager Custom Menu**

2. Select the *Software / Install New* option from the Main Menu using the right arrow key, then press *Enter*, as shown in Figure 2.

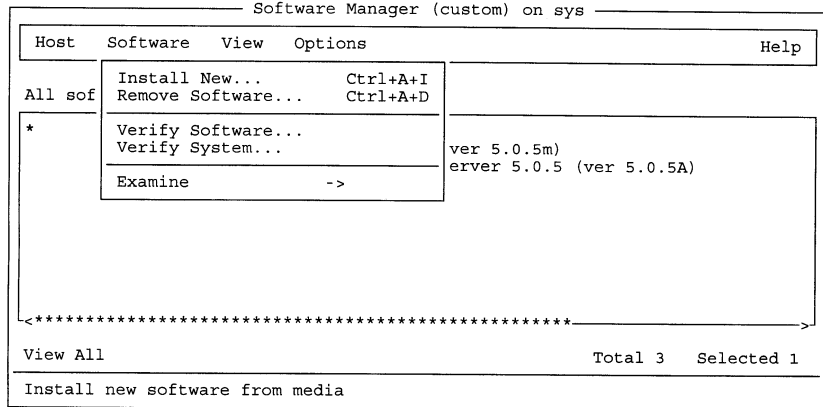

**Figure 2. Selecting the Software Install Option**

3. Select *From sys [host name]*, press *Tab* to select Continue, and press *Enter*.

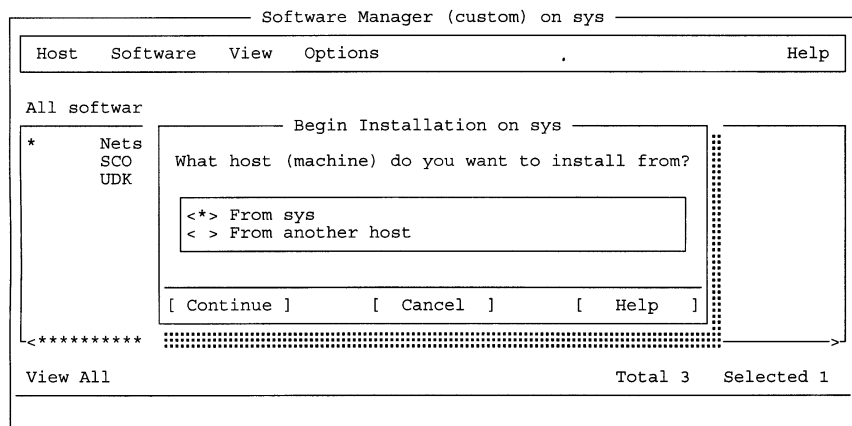

**Figure 3. Selecting Load Source**

- Use the *down arrow key* to select **Floppy Disk Drive 0**, press *Tab* to move the cursor to **Continue** and press *Enter*.

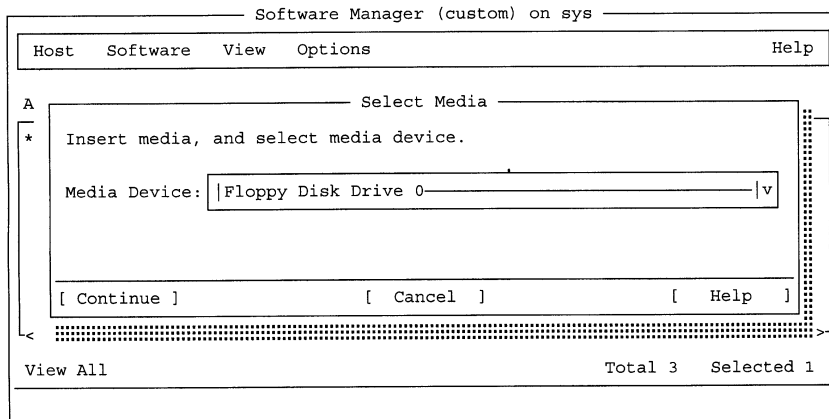

**Figure 4. Selecting the Load Drive**

- Select from the list of drivers. In this instance, only the **Computone IntelliPort Plus Driver (ver. 2.2.1)** is displayed. Press *Tab* to select **Install** and press *Enter*.

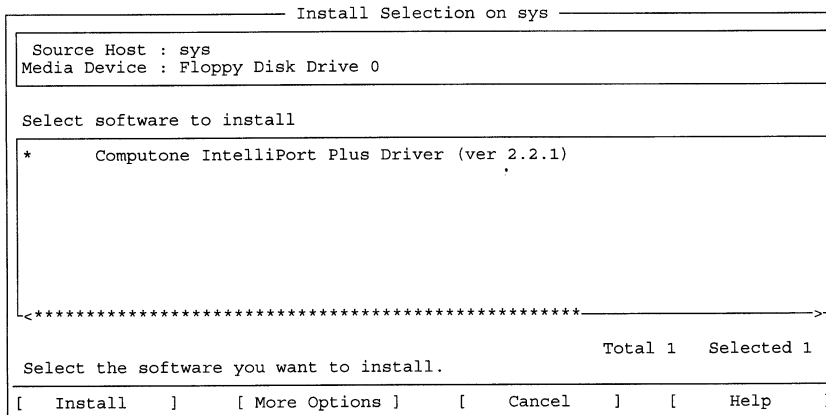

**Figure 5. Driver Selection**

---

At this point the software begins loading and the IntelliPort II Installation Program banner block is displayed, as shown below. Press any key to continue.

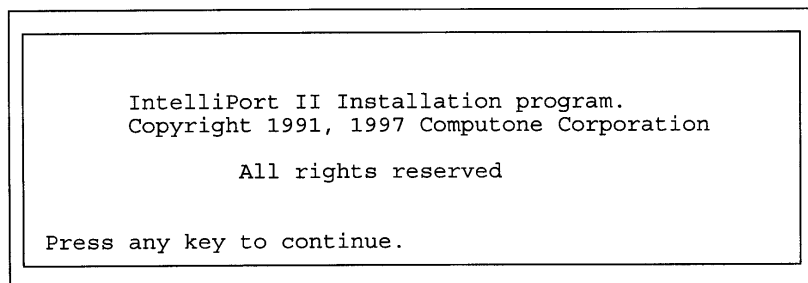
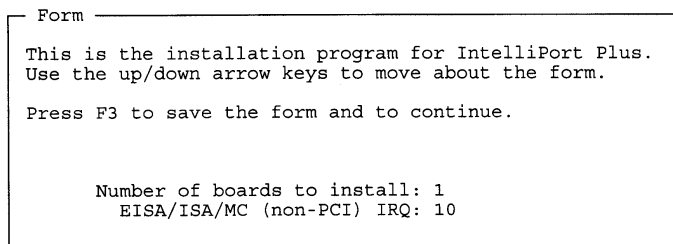

**Figure 6. Installation Program Banner**

---

The following Form Screen is displayed.

F1	F2	F3	F4	F5	F6
Help	List	Save	Cancel		Clear
	Choices	Form	Form		Field



**Figure 7. Selecting Software to Install**

---

6. Select the *Number of boards to install* in the system (Press F2 for choices).

---

---

F1	F2	F3	F4	F5	F6
Help		Select	Cancel		
		Item	Choices		

```
Choices
->1
 2
 3
 4
```

```
Form
This is the installation program for IntelliPort Plus.
Use the up/down arrow keys to move about the form.

Press F3 to save the form and to continue.

Number of boards to install: 1
EISA/ISA/MC (non-PCI) IRQ: 10
```

**Figure 8. Selecting Number of Controllers**

---

7. Use the *down arrow key* to move the cursor to the **IRQ** selection (Press *F2* for choices). After making your selection, press *F3* to save the form and go to the next screen.

**NOTE:** If you are installing a PCI board, select IRQ 0.

F1	F2	F3	F4	F5	F6
Help		Select Item	Cancel Choices		

```

  Choices
  ->10
     11
     12
     15
     5
     7
     0

```

e installation program for IntelliPort Plus.  
 Use the up/down arrow keys to move about the form.  
 Press F3 to save the form and to continue.

Number of boards to install: 1  
 EISA/ISA/MC (non-PCI) IRQ: 10

**Figure 9. Selecting the IRQ**

**IMPORTANT:** If you press *F2* and no interrupts are available, stop the installation and call Computone Technical Support at **1-800-241-3946, x2002**.

8. Move the cursor to Board Type and press *F2*.

F1	F2	F3	F4	F5	F6
Help	List Choices	Save Form	Cancel Form		Clear Field

```

  Form
  All boards REQUIRE a unique I/O address range.
  Use the arrow keys to move about the form.

  Press F3 to save the form and to continue.

  Board      Board Type      I/O addr or Slot #  Max Screens/Terminal
  Board 1           Range 1                2

```

**Figure 10. Setting Board Type**



**NOTE:** You can get the **Board Type** from the carton the board came in. For example, ISA CEX would be a valid **Board Type**.

- For ISA and Micro Channel controllers, specify the base I/O address that this controller is to use. You must assign a unique base I/O address to each IntelliPort II controller.
- For EISA controllers, specify the slot number that this controller is to use. You must assign a unique slot to each Intelliport II controller.
- For PCI controllers, leave I/O address at default.

9. Move the arrow to your selection and press *Enter*.

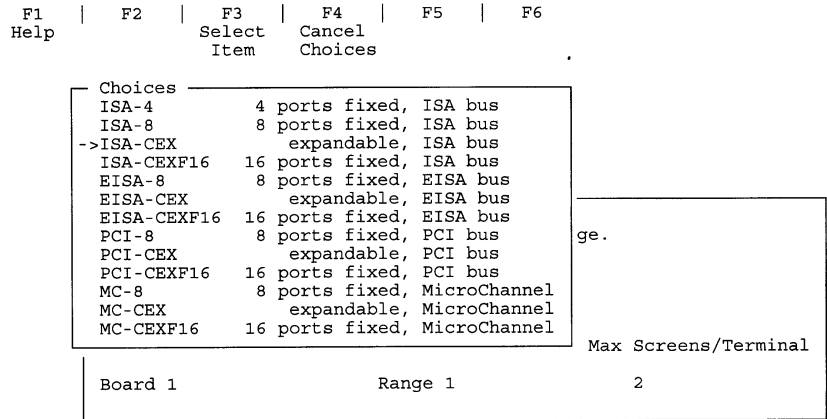

**Figure 11. Board Type Choices (after F2 is pressed)**

- 
10. Move the cursor using the right arrow key to *I/O addr or Slot #* and press *F2*.  
Move the arrow to the address range you are going to use and press *Enter*.

**NOTE:** If you installing more than one board, each board must have its own unique I/O address range.

```
Item      Choices

Choices
->308 30F
 310 317
 318 31F
 320 327
 328 32F
 330 337
 338 33F
 340 347
 348 34F
 350 357
 358 35F
 370 377
 390 397
 398 39F
 3D0 3D7

      REQUIRE a unique I/O address range.
      row keys to move about the form.
      o save the form and to continue.

Board Type      I/O addr or Slot #      Max Screens/Terminal
ISA-CEX         308 30F                          2
```

**Figure 12. Selecting Unique I/O Address Range**

---

11. Use the *right arrow key* to move the cursor to **Max Screens/Terminal** and press *F2*. Move the selection arrow to select the number of screens per terminal and press Enter. Press *F3* to save inputs and to go to the next screen.

F1 Help	F2	F3 Select Item	F4 Cancel Choices	F5	F6
------------	----	----------------------	-------------------------	----	----

Choices 1 ->2 3 4 5 6 7 8	REQUIRE a unique I/O address range. row keys to move about the form.  Press F3 to save the form and to continue.  <table border="1"> <thead> <tr> <th>Board</th> <th>Board Type</th> <th>I/O addr or Slot #</th> <th>Max Screens/Terminal</th> </tr> </thead> <tbody> <tr> <td>Board 1</td> <td>ISA-CEX</td> <td>308 30F</td> <td>2</td> </tr> </tbody> </table>	Board	Board Type	I/O addr or Slot #	Max Screens/Terminal	Board 1	ISA-CEX	308 30F	2
Board	Board Type	I/O addr or Slot #	Max Screens/Terminal						
Board 1	ISA-CEX	308 30F	2						

**Figure 13. Selecting Screens/Terminal**

If you specify four or more screens per terminal (one main screen and three or more alternate screens), the installation program prompts you to confirm the number of screens specified. Most terminals support three or less screens.

**Table 1. Number of Screens Selected**

Number of Screens	Enables IntelliView Main Screen Plus
1	Zero (0) Alternate Screens
2	One (1) Alternate Screen
3	Two (2) Alternate Screens
4	Three (3) Alternate Screens
5	Four (4) Alternate Screens
6	Five (5) Alternate Screens
7	Six (6) Alternate Screens
8	Seven (7) Alternate Screens

**NOTE:** To change **Max Screens/Terminal** later, reinstall the drivers.

12. Select the number of ports per box for this board. Press F3 to save form and go to next screen.

F1	F2	F3	F4	F5	F6
Help	List Choices	Save Form	Cancel Form		Clear Field

```

Form
-----
Fo  Please enter the number of ports per box for this board
All Use the arrow keys to move about the form.
Use Press F3 to save the form and to continue.
Pre
Boa          Board 1
Boa          Box 1   Box 2   Box 3   Box 4
Boa          16     0     0     0
  
```

Figure 14. Selecting Ports-per-Box

13. Set the board switches as shown. Then, press F3 to save form and go to next screen.

F1	F2	F3	F4	F5	F6
Help	List Choices	Save Form	Cancel Form		Clear Field

```

Form          Help
-----
All bo Set board switches as follows.
Use th Record these settings in the User Manual Hardware Log.
Press          SW1 SW2 SW3 SW4 SW5 SW6 SW7 SW8
Board1 Off Off On  On  On  On  Off On
Board          Press any key to continue.
Board
  
```

Figure 15. Setting Board Address Switches

14. Remove the software driver disk from the drive, select *OK* and press *Enter*.

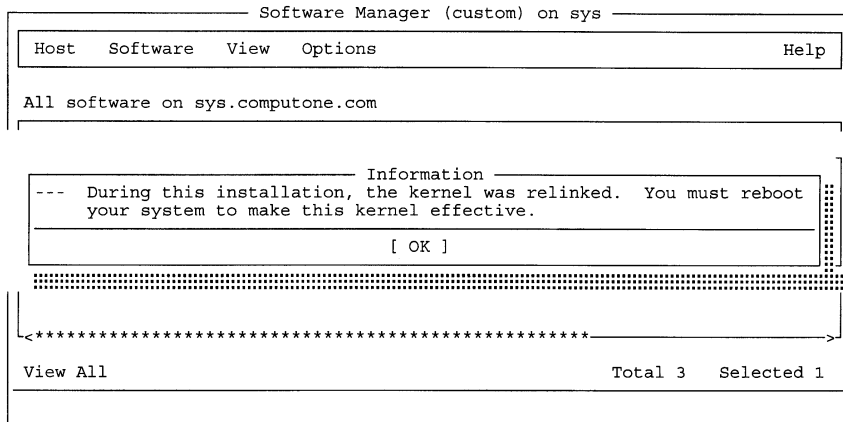

Figure 16. Re-linking the Kernel

15. Select *OK* and press *Enter*.

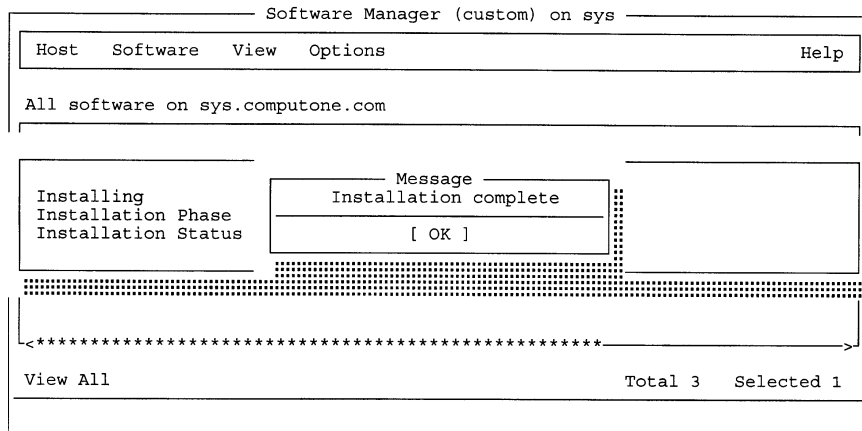

Figure 17. Installation Complete

16. Select Host, then Exit.

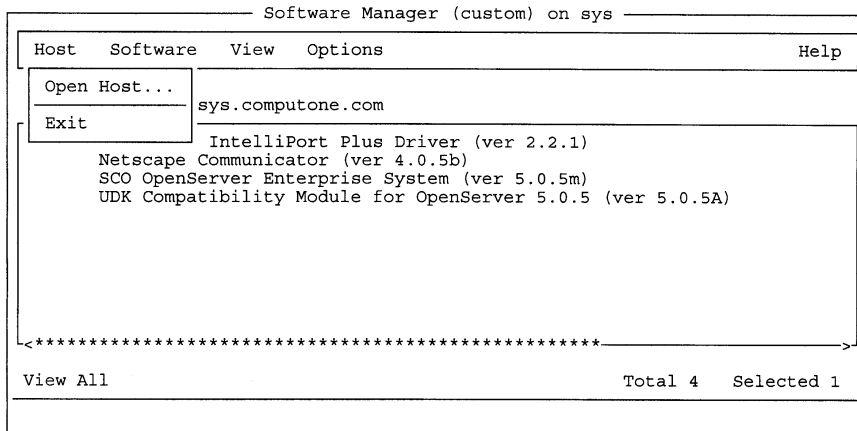

Figure 18. Exiting the Program

17. Type *sync* at the # prompt, then press *Enter*.

18. Type *shutdown -g 0 -y* at the # prompt.

If you did a PNP (Plug aNd Play) and PCI installation, you must check CMOS for availability of IRQ10.

End of Procedure